

HDMI MATRIX SWITCHER
B-120-HDMATRIX-8x8

BINARY

INSTALLATION
MANUAL



FC CE

IMPORTANT SAFETY INSTRUCTIONS

To reduce the risk of fire or electric shock, read and follow all instructions and warnings in this manual. Keep this manual for future reference.

1. Do not expose this apparatus to rain or moisture. Do not expose this equipment to dripping or splashing, and ensure that no objects filled with liquids, such as vases, are placed on the equipment. Do not use this apparatus near water.
2. Do not remove cover. No user serviceable parts inside.
3. Clean only with a dry cloth.
4. Do not block any ventilation openings. Install according to manufacturer's instructions.
5. Do not install near any heat sources such as radiators, heat registers, stoves or other apparatus (including amplifiers) that produce heat.
6. Do not override the safety purpose of the polarized or grounding plug. A polarized plug has two blades, one of which is wider than the other. A grounding plug has two matching blades and a third grounding prong. The wide blade or the third prong is provided for your safety. If the provided plug does not fit into your outlet, consult an electrician for replacement of the obsolete outlet.
7. Protect the power cord from being walked on or pinched, particularly at the plug end and where the power cord is attached to the apparatus.
8. Only use attachments and accessories specified by the manufacturer.
9. Refer all servicing to qualified service personnel. Servicing is required when the apparatus has been damaged in any way, such as when the power-supply cord or plug is damaged, liquid has been spilled on or objects have fallen into the apparatus, the apparatus has been exposed to rain or moisture, the apparatus does not operate normally, or it has been dropped.
10. To completely disconnect this equipment from power, disconnect the power supply cord from the power outlet.

LEGAL NOTICE

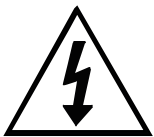

The lightning flash with arrowhead symbol, within an equilateral triangle, is intended to alert the user to the presence of uninsulated dangerous voltage within the product's enclosure that may be of sufficient magnitude to constitute a risk of electric shock to persons.



The exclamation point within an equilateral triangle is intended to alert the user to the presence of important operating and maintenance (servicing) instructions in the literature accompanying the appliance.



CONTENTS

1. Product Overview	4
2. Features	4
3. Package Contents.....	4
4. Recommended for Installation.....	5
5. Device Layout.....	5
5.1. Front Panel of the B-120-HDMATRIX-8x8 Switcher	5
5.2. Rear Panel of the B-120-HDMATRIX-8x8 Switcher	6
6. Installation & Setup.....	6
6.1. Basic Installation Diagram	6
6.2. Basic Instructions.....	7
6.3. Installation Tips.....	7
6.4. Switcher Location and Placement	8
6.4.1. Rack Installation.....	8
6.5. HDMI Input Connections.....	8
6.6. HDMI Outputs.....	8
6.7. Matrix Control Connections.....	8
6.7.1. RS-232 Control	9
6.7.2. Ethernet/IP Control	9
6.8. Matrix Switcher IR Connections	9
6.8.1. Matrix Switcher IR Port Configuration	9
7. EDID Configuration	10
7.1. Source Setup	10
7.2. Display Setup	10
7.3. Auto EDID Configuration.....	10
7.3.1. How to Configure Auto EDID.....	11
7.4. Embedded EDID Configuration.....	11
7.4.1. Embedded EDID Chart	11
7.4.2. How to Set Embedded EDID for a Single Input.....	12
7.4.3. How to Set Embedded EDID for All Inputs.....	12
7.5. EDID Learning.....	12
7.5.1. How to Learn EDID to a Single Input.....	12
7.5.2. How to Learn EDID to All Input.....	12
7.6. Viewing Input EDID Status.....	13
8. Advanced Setup Using the Configuration Utility.....	13
8.1. IR Front Panel IR Enable	13
8.2. Matrix Control from Room Enable.....	13
8.3. Front Panel Power Button Active	14
9. Firmware Update.....	14
10. Operation and Control	14
10.1. IR Remote	14
10.1.1. Route Inputs to Outputs.....	15
10.1.2. Turn Off (Mute) Outputs	15
10.1.3. Display Output Status	15
10.1.4. Resetting to Factory Defaults	16
11. Troubleshooting	16
11.1. General Troubleshooting Guidelines.....	16
11.2. No Signal from Source to Any Display.....	16
11.3. No Signal from any Source to any Display	17
11.4. Audio Issues.....	17
12. System Layout Chart	18
13. Specifications.....	19
14. Contacting Tech Support	20
15. Warranty	20

1. PRODUCT OVERVIEW

Welcome to Binary™. This product is engineered to provide years of exceptional reliability. We appreciate your business, and we stand committed to providing our customers with the highest degree of quality and service in the industry.

The B-120-HDMATRIX-8x8 is a state-of-the-art HDMI matrix switcher with HDMI outputs. It provides true matrix routing for HDMI signals. With features such as HDMI 3D support, sophisticated EDID handling, and IR, RS-232 and Ethernet control, this product is ideal for residential and commercial media distribution systems.

Note: This manual covers installation and setup of the B-120-HDMATRIX-8x8 for most applications. Some features must be configured using the Configuration Utility software. Go to the product page for the B-120-HDMATRIX-8x8 at www.SnapAV.com and click on the **Support** tab to download the Configuration Utility and manual.

2. FEATURES

- 8 HDMI inputs by 8 HDMI outputs
- Supports video resolutions up to 1080p/60 36bit color
- Supports all HDMI audio formats
- Supports all HDMI 3D formats
- Sophisticated EDID handling including embedded, learned, and auto modes
- HDMI or DVI with adapter (not included)
- IR Control from integrated receiver or 3.5mm input
- Home Control via IR, RS-232 and Ethernet
- PC Setup and configuration using dedicated software
- HDCP 2.0 compliant
- CEC Passthrough

3. PACKAGE CONTENTS

- 1x B-120-HDMATRIX-8x8
- 2x rack ears for mounting
- 8x screws
- 1x IR remote control
- 1x Power supply 12VDC, 5A
- 1x Installation Manual
- 1x CD-ROM

4. RECOMMENDED FOR INSTALLATION

- Phillips screwdriver (for rack ear attachment)
- Binary high-speed HDMI cables to connect sources to B-120-HDMATRIX-8x8 HDMI inputs
- Control system to control operation of B-120-HDMATRIX-8x8
- Windows PC with Configuration Utility installed and RS-232 adapter
- Configuration Utility Manual

5. DEVICE LAYOUT

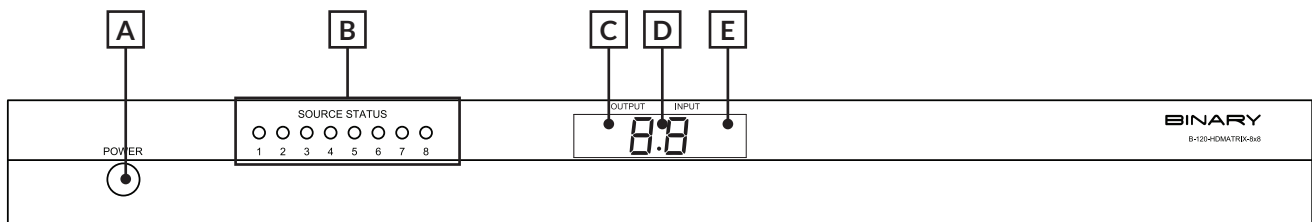

FIGURE 1: B-120-HDMATRIX-8x8 Switcher Layout (Front View)

5.1. Front Panel of the B-120-HDMATRIX-8x8 Switcher

A. Power On/Off Switch

Lights up blue when power is on and lights up red when in stand-by. Can be disabled from configuration utility software

B. Source Status LEDs

Indicates that the selected source is **On** and transmitting an HDMI signal

C. Output Display

Displays the last output selected

D. IR Receiver Window

IR receiver for matrix to capture commands sent by IR remote

E. Input Display

Displays the last input selected

5.2. Rear Panel of the B-120-HDMATRIX-8x8 Switcher

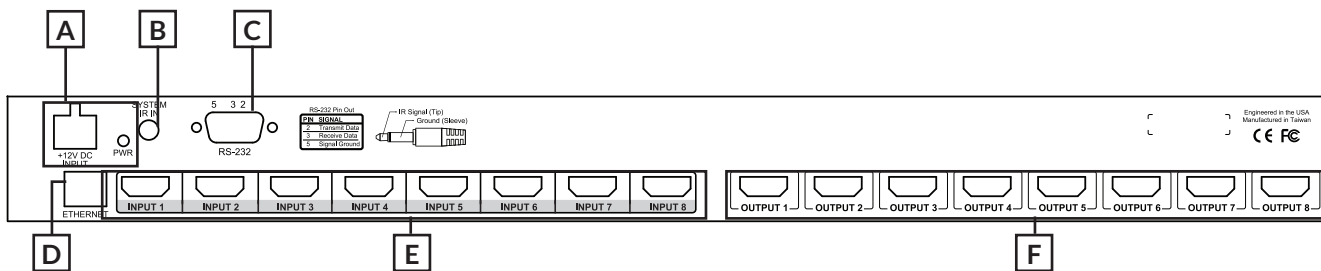

FIGURE 2: B-120-HDMATRIX-8x8 Switcher Layout (Rear View)

A. Power Jack

+12V DC, 5A power supply connection

B. System IR In

To connect a control system with 3.5mm mono IR input for matrix control

C. RS-232 control port (DB9)

To communicate with control system or Windows PC for serial control of matrix

D. Ethernet Port

RJ45 port for connecting an ethernet Cat5e/6 cable for IP control of the B-120-HDMATRIX-8x8

E. HDMI Inputs (1 through 8)

Connect HDMI cables from sources to the matrix switcher for distribution

F. HDMI Outputs - (1 through 8)

Connect HDMI cables from matrix switcher to displays.

6. INSTALLATION & SETUP

6.1. Basic Installation Diagram

Complete the basic installation section to set up the matrix switcher for media distribution before completing any other setup. Use this diagram for reference during basic installation of the matrix switcher, sources, displays, and wiring.

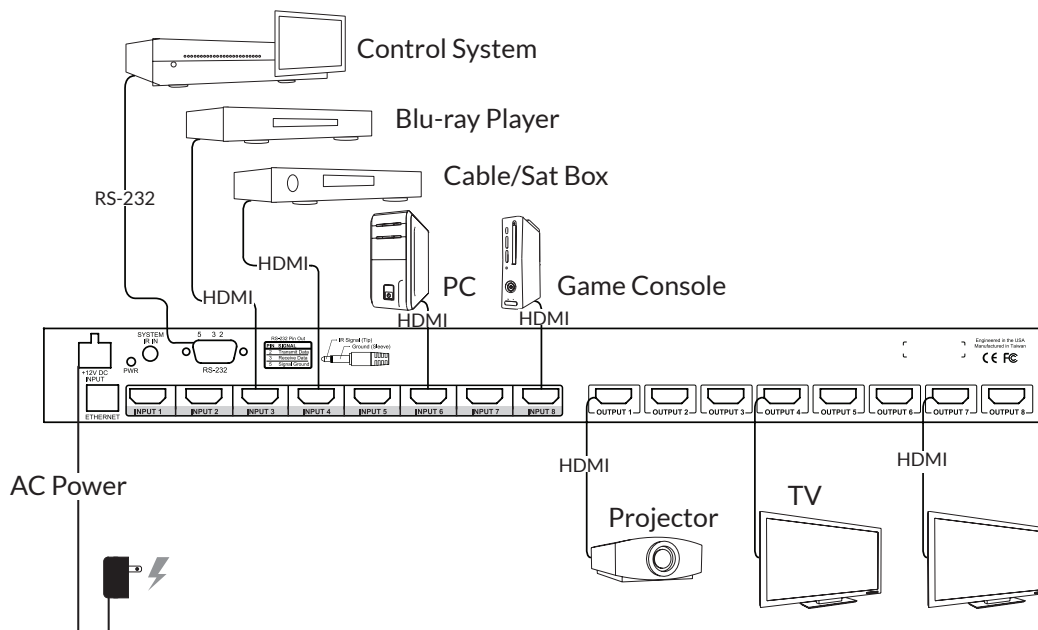

FIGURE 3: B-120-HDMATRIX-8x8 Installation

6.2. Basic Instructions

These are basic steps that must be taken to connect equipment to the inputs and outputs of the matrix switcher and configure the system for use. See the sections listed for full information on completing each step.

1. Unpack the matrix and install it near the source equipment. (6.4. Switcher Location and Placement, page 8).

Note: Do not power the matrix switcher until it is indicated to do so.

2. Install and connect each source to an input on the matrix switcher using the shortest HDMI cable possible. (6.5. HDMI Input Connections, page 9).
3. Install the displays and output wiring to the matrix location using HDMI cables for standard HDMI output.
4. Record the inputs and outputs used in the System Layout Chart for future reference. (13. System Layout Chart, page 26).
5. If using a control system, connect it to the appropriate port on the matrix switcher for the driver type being used: IR, RS-232, or IP control. (6.7. Matrix Control Connections, page 11).
6. Install and configure the driver for matrix switching control into the control system processor. (6.7. Matrix Control Connections, page 11).
7. Install the IR equipment and set up IR passthrough if using it. (6.8. IR Passthrough Installation and Setup, page 11).
8. Attach the power supplies to the matrix, sources, and displays to power up the system.
9. Test all input and output selections for sync, reliable switching, correct audio format and video resolution. Use the factory remote or the Matrix Configuration Utility to set up EDIDs as needed. (7. EDID Configuration, page 16).
10. Change any advanced settings in the Matrix Configuration Utility as needed to suit the installation. (8. Advanced Setup Using the Configuration Utility, page 19).

TV

6.3. Installation Tips

Following these tips during the installation process will help guarantee a successful installation.

- Label each cable as it is installed.

This will aid in connection setup and programming, and will also make it easier to come back to a job at a later date and immediately know what is connected where.

- Complete the System Layout Chart (page 25) in the back of the manual during installation.

Record the source connected to each input, the output number of each display, and the method of routing signal in the chart for reference during installation and setup. Use it afterward to keep track of equipment in use, open ports for expansion, and to help identify where to troubleshoot issues if they arise later.

- Leave an RS-232 connection easily accessible for using the Configuration Utility.

The B-120-HDMATRIX-8x8 is equipped with many setup functions that must be accessed by using a PC and the Configuration Utility. Leave an RS-232 cable connected during setup and testing that can easily be connected to the PC. If the matrix is being controlled by RS-232, disconnect the control system while using the Utility.

- **Do not** fully secure wiring and equipment until setup and testing has been successfully completed.

Wait until all programming, sources, and zones have been set up and thoroughly tested to strap wiring and equipment down, in order to avoid restricting access to connections and settings on the equipment.

- Complete initial setup with all sources connected to the matrix locally.

If a source will be connected to an input by an HDMI extender, complete initial setup by connecting directly to the input with a short HDMI cable. Relocate the source and install the extender after the source has been set up and tested, and then confirm the new arrangement works.

6.4. Switcher Location and Placement

Binary matrix switchers are designed to deliver unsurpassed technology with superior performance. However, where you install the switcher could greatly affect the performance of the system, and the life of the unit. Here are some guidelines to follow when installing a B-120-HDMATRIX-8x8 switcher.

- Be sure that the unit is in a well-ventilated area that provides adequate cooling.
- Do not block the cooling vents located on both sides of the unit.
- Do not place the unit on carpeting or any similar material.
- Do not install the unit near a source of heat, or in an extremely humid or wet location.
- If your enclosure lacks good air flow (such as solid cabinet doors or wall-mounted racks), it may be necessary to create ventilation to allow outside air into the space.
- Allow a minimum of 3" of free air space on either side of the unit. (Does not apply to rack mounting).
- Allow a minimum of 2" of depth behind unit to accommodate cables and connectors.
- When placing on a cabinet shelf, position the unit with all feet resting on a solid level surface.

6.4.1. Rack Installation

The B-120-HDMATRIX-8x8 can be mounted in a rack with the front or rear panel facing outward, and will displace 1U of vertical space when installed. Rear-facing installation allows for easy access to the connections for installations that do not require the front panel of the unit to be accessed. Front-facing mounting is useful for applications where the front panel must be accessible or visible.

The rack ears are packaged separately from the matrix switcher in the box. Attach the ears to the sides of the matrix at the front or back using the included screws. Tighten with a #2 Phillips Screwdriver. It may be necessary to remove the feet from the bottom when rack mounting the matrix switcher. Remove the screws for the feet with a #2 Phillips Screwdriver and store the feet and screws together in case they are needed in the future.

Note: The rack ears and mounting holes are only designed to safely hold the weight of the B-120-HDMATRIX-8x8.

CAUTION: Do not use the matrix switcher as a shelf for other equipment in the rack.

6.5. HDMI Input Connections

Each of the eight inputs on the B-120-HDMATRIX-8x8 utilize a standard HDMI port for connection. Follow these guidelines when connecting sources to the inputs.

- Always use the shortest cable possible between source equipment and the matrix switcher inputs. Use high-speed rated cables to guarantee the best possible performance.
- Always run one continuous cable when possible and avoid using HDMI cable adapters in runs.

6.6. HDMI Outputs

The HDMI outputs of the matrix can be connected to the input of a sink device (TV, AV receiver, fiber extender, etc.). Please follow the guidelines below to ensure best performance and reliability.

- Always use the shortest, possible cable between equipment. Use high-speed rated cables to guarantee the best possible performance.
- Always run continuous HDMI cables and avoid using HDMI cable adapters.
- When routing HDMI to an AV receiver, make sure to set the AV receiver to an HDMI mode where the signal will not be processed or scaled to a different format. This will avoid signal timing issues that can cause intermittent sync or total loss of sync. Contact the device manufacturer for details regarding HDMI setup.

6.7. Matrix Control Connections

All drivers, associated software and extra documentation is available under the **Support** tab on the B-120-HDMATRIX-8x8 product page at www.SnapAV.com.

Note: System IR control and the front panel IR receiver can be disabled when not in use by using the Configuration Utility. See the Configuration Utility Manual section, **Other Settings** for more information.

6.7.1. RS-232 Control

To control the B-120-HDMATRIX-8x8 with RS-232, the devices must connect using the correct pin configuration for the control system in use.

The matrix switcher receives control data on pin 2 (RxD – Data Receive) and transmits control data on pin 3 (TxD-Data Transmit). See the diagram below for details.

Configuration for control system serial ports can vary. Refer to the documentation for the system in use to ensure proper connection and configuration.

Note: This port is also used to communicate with a PC when using the PC Configuration Utility. Refer to the Configuration Utility Manual for details.

Pin	Function
2	RxD (Data Receive)
3	TxD (Data Transmit)
5	Ground/Common

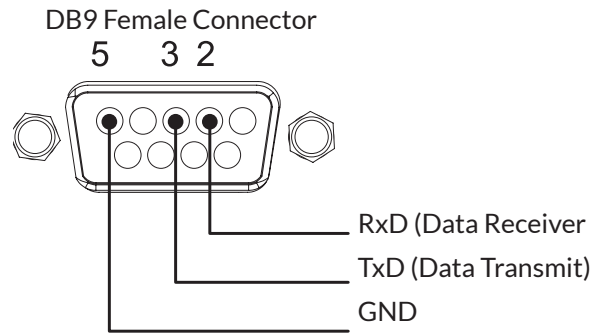

FIGURE 4: RS-232 (DB9) Pin Configurations

6.7.2. Ethernet/IP Control

The B-120-HDMATRIX-8x8 includes an Ethernet port that can be used to control the device using Telnet Protocol. This port follows TIA 568B standards; please refer to these standards when terminating cables.

To configure the matrix switcher for use with the driver, it will be necessary to connect the unit to a PC and access it with the Matrix Configuration Utility. See the Configuration Utility Manual and the IP driver documentation for complete setup instructions.

6.8. Matrix Switcher IR Connections

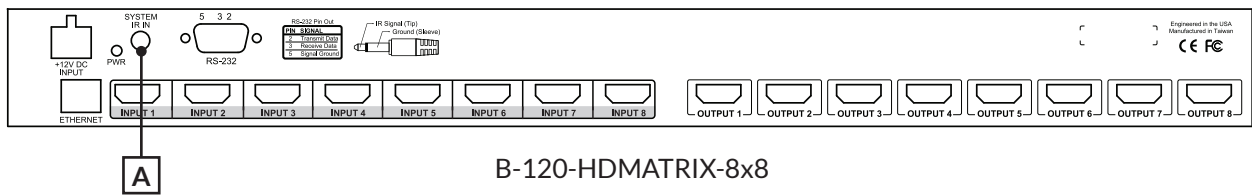

B-120-HDMATRIX-8x8
FIGURE 5: IR Connections

A. System IR In (3.5mm mono)

IR input port for matrix switcher IR control.

6.8.1. Matrix Switcher IR Port Configuration

The System IR In on the B-120-HDMATRIX-8x8 is 3.5mm mono and only uses this pinout configuration.

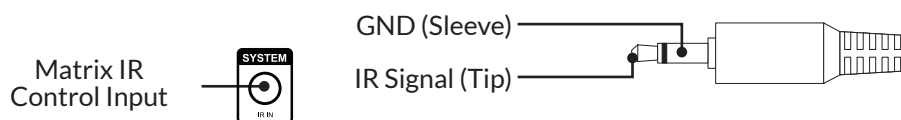

FIGURE 6: IR Port Configuration

Consult with the manufacturer of any attached IR equipment to confirm their pinout matches before use. Visit our website for HEX codes under the support tab of this product’s page.

7. EDID CONFIGURATION

The displays used within an installation usually vary from room to room, and some may not support all resolutions available from a source. It is necessary to make sure sources will provide a video and audio format compatible with all connected displays programmed to use them. To accomplish this, the B-120-HDMATRIX-8x8 includes built-in EDID management for each source input. The stored EDID is per source, so all display locations will see the same resolution and have the same audio format when that source is selected.

Note: Source is only able to output one video resolution and one audio format.

Note: The default EDID for each input is always 1080p with 2-channel stereo audio, since this format is accepted by most displays with no issues.

The following sections explain configuring EDIDs via the included IR remote. Before configuring the EDID, be sure to refer to the source and display manuals for available features and resolutions for each device. For more information about using the included remote, see Section 10.1 *IR Remote* on page 21.

While all EDID configurations are available via the remote, the Configuration Utility can be used for faster setup. Download the Configuration Utility and manual on the **Support** tab at the product page for the B-120-HDMATRIX-8x8 at www.SnapAV.com.

What is EDID? EDID, or Extended Display Identification Data, is a stream of information sent from a display to a source when the two devices are connected to tell the source what video and audio formats the display can use. This prevents sources from outputting media that won't work with the display.

7.1. Source Setup

Check each source and confirm that the audio format and video resolution are set so that they will change based on the EDID. Normally this setting is called *Auto* or similar.

Note: EDID setup is not required if the source supports setting one fixed video resolution and audio format.

7.2. Display Setup

It is recommended that Consumer Electronics Control (CEC) be turned **OFF** in all displays when using the B-120-HDMATRIX-8x8. This will provide for proper communication of video/audio signals and allow EDIDs to function at their optimum performance. Refer to the display's manual for information on how to turn this function **OFF**.

7.3. Auto EDID Configuration

The quickest and easiest method for configuration is to use Auto EDID. When this mode is used the matrix switcher looks at the EDID from each of the connected displays. It uses the highest common video resolution to create a new EDID and saves that EDID in all of the inputs.

Note: Auto EDID sets audio to 2-channel stereo for all inputs regardless of the capability of the connected displays. If multi-channel audio is desired, embedded EDIDs or Learned EDIDs will need to be used.

When to use Auto EDID

- All sources will be available on all displays.
- As a first step to configuration following up with advanced methods for particular displays and dedicated sources.
- For advanced EDID configuration when using a legacy display and/or dedicated sources, use embedded EDIDs or learning as described in the following sections.

7.3.1. How to Configure Auto EDID

To set up Auto EDID configuration, first make sure that all displays are powered on and connected to the matrix switcher. Then, press the following remote buttons in this order. Be sure to press each button within 10 seconds of the previous button-press to prevent the command from resetting.

Sets EDID Based on All Connected Displays	Display Readout (Example)
1. Press DEFAULT	E-
2. Press Number Key 9	AA
3. Press ENTER	A0

7.4. Embedded EDID Configuration

In addition to the automatic configuration method, EDIDs in the B-120-HDMATRIX-8x8 can be set to inputs manually by selecting an EDID from the embedded list (default EDIDs programmed into the matrix switcher).

The matrix switcher contains eight 'embedded' EDIDs that may be assigned to inputs. These EDIDs define groups of video and audio capabilities that are useful for configuring sources in most systems.

7.4.1. Embedded EDID Chart

Embedded EDID	Resolution	Color Depth	Audio
1	1080p@60Hz	24-Bit	7.1ch
2 (Factory Default)	1080p@60Hz	24-Bit	2ch
3	1080p@60Hz	24-Bit 3D	7.1ch
4	1080p@60Hz	24-Bit 3D	2ch
5	1080i@60Hz	36-Bit 3D	7.1ch
6	1080i@60Hz	36-Bit 3D	2ch
7	1080i@30Hz / 720p@60Hz	24-Bit	7.1ch
8	1080i@30Hz / 720p@60Hz	24-Bit	2ch

Explanation of Embedded EDIDs

Video Resolution in the Embedded EDIDs is the highest resolution a connected source will output. That is, if the source is capable of 1080P@60 it will be required by EDIDs 1-6 to provide that resolution. However, if the source is only capable of 1080i it will output 1080i, etc. It is assumed that any display that can accept the specified video resolution can also accept all standard video resolutions less than that specified.

Color Depth is the maximum number of bits used to encode color.

3D indicates that the source can output 3D if it is available in the content.

Audio Format indicates the maximum number of audio channels, as well as the audio format that the source is allowed to output. For an Embedded EDID with 7.1ch Audio Format, the source device will output the highest audio possible based on the content. For example, if 7.1ch is not available and 5.1ch is available, then the output will be 5.1ch. The same is true if 2ch stereo is the only audio available from the source. Embedded EDIDs with 2ch stereo will limit output to that audio format regardless of what is available in the content.

Embedded EDIDs 7 and 8 are provided for legacy displays that can only accept resolutions up to a maximum of 1080i / 720p. The 1080i is listed first since almost all older HD displays can accept 1080i but not all can accept 720p. For these two Embedded EDIDs, (7&8) the source will output 1080i. Should 1080i not be available, the source will output 720p.

Note: There is a possibility that 720p may not work for a very small number of older displays that may still be in use. It will be necessary to use a learned EDID from the display to store in the input EDID of any sources that will be routed to that display if 720p is not supported. See Section 8.5. *EDID Learning* on page 18 for directions to set a learned EDID.

When to Use Embedded EDIDs

- 2-channel audio is required for a particular output.
- Lower video resolution is required for a particular output.

7.4.2. How to Set Embedded EDID for a Single Input

Example: Input =1 Embedded EDID=4	Display Readout (Example)
1. Press DEFAULT	E-
2. Press Number Key (1-4) to select one Embedded EDID	4A
3. Press INPUT	4A
4. Press Number Key (1-8) to select the Input to which the EDID is applied	41
5. Press ENTER	--(success) FF (fail)

7.4.3. How to Set Embedded EDID for All Inputs

Example: Input =1 Embedded EDID=4	Display Readout (Example)
1. Press DEFAULT	E-
2. Press ALL to select all Inputs	A-
3. Press Number Key (1-4) to select Embedded EDID	4A
4. Press ENTER	--(success) FF (fail)

7.5. EDID Learning

For more advanced EDID configuration, learning can be used to assign EDIDs directly from displays to one or more inputs. This is useful when the system contains a display that cannot accept the highest resolution available from sources, but all sources need to be available to all displays.

When to Use Learned EDIDs

- An older display does not work properly with any of the embedded EDIDs.
- When the source is a PC it may be necessary to use a learned EDID.
- Learning EDID to a single input

7.5.1. How to Learn EDID to a Single Input

Example: Input =1 EDID Learned from Output 4	Display Readout (Example)
1. Press LEARN	L-.
2. Press OUTPUT	1A
3. Press Number key (1-8) to select the Output the EDID is learned from	14
4. Press INPUT	L-
5. Press Number Key (1-4) to select the Input to which the EDID is applied	1A
6. Press ENTER	--(success) FF (fail)

7.5.2. How to Learn EDID to All Input

Example: Input=All EDID Learned from Output 4	Display Readout (Example)
1. Press LEARN	L-.
2. Press OUTPUT	L-
3. Press Number Key (1-8) to select the Output the EDID is learned from	4
4. Press ENTER	--(success) FF (fail)

7.6. Viewing Input EDID Status

If there is a question about the EDID set for an input, the status of that input's EDID can be reviewed using the included IR remote and watching the matrix switcher front panel display.

Example: View the EDID for Input 3.	Display Readout (Example)	
	EDID 5 Assigned from Embedded EDID Table	EDID Learned from Output 4
1. Press STATUS	--	--
2. Press INPUT	--	--
3. Press Number Key (1-8) to select the desired Input	-3	-3
4. Press ENTER	5.3.	4.3

Notes about EDID Status

- If the EDID was learned from an output, the exact EDID specifications will not be shown, but the output number will be identified. Review the specifications of the display attached to the output to determine its compatible resolutions.
- If the second digit (the Input being queried) has a dot after it, then the first digit is the EDID number from the Embedded EDID table.
- If the second digit (the Input being queried) does not have a dot after it, the first digit is the output the EDID was learned from (step 4 from example above).

8. ADVANCED SETUP USING THE CONFIGURATION UTILITY

There are several setup options available that can only be modified using the matrix switcher Configuration Utility. These items are defaulted to the most common settings that should work in most installations.

The Configuration Utility and manual are available for download on the **Support** tab of the B-120-HDMATRIX-8x8 product page at www.SnapAV.com. Download and run the utility to gain access to these settings connecting to the matrix and clicking **Other Settings**.

8.1. IR Front Panel IR Enable

Default Setting:

Yes

This setting controls the operation of the front panel IR receiver built into the B-120-HDMATRIX-8x8. This should be disabled if using the **SYSTEM IR IN** port to control the matrix switcher via IR, or if the matrix switcher is missing or receiving extra commands during use (stray IR interfering with the port).

8.2. Matrix Control from Room Enable

Default Setting:

Yes

The Matrix Control From Room Enable option allows Matrix Control IR commands to be sent from the room as if a source were being controlled. Turn this option off if the matrix switcher is being controlled by any other method than in-room IR.

Note: To use Matrix Control From Room, it is recommended to program a universal remote control with discrete commands for matrix control to keep in each zone, rather than using the included IR remote or commands learned from it. Go to the **Support** tab of the B-120-HDMATRIX-8x8 product page at www.SnapAV.com to see and download the available IR codes and drivers for IR remote programming.

8.3. Front Panel Power Button Active

Default Setting:	Yes
-------------------------	-----

The front panel power button can be disabled if desired. Disable the button when the matrix switcher is programmed to be on at all times or in jobs where turning off the matrix from the switcher can cause issues with control.

9. FIRMWARE UPDATE

Binary™ may occasionally release new firmware for the B-120-HDMATRIX-8x8 to address new standards and technology. It will never be necessary to perform an update to an existing, correctly functioning system, but during installation or service, it is recommended to check the installed version to be sure it is the newest available.

For full update instructions, see the section titled *Firmware Update* in the Configuration Utility Manual. New firmware, the Configuration Utility, and the Configuration Utility Manual are available for download on the **Support** tab of the B-120-HDMATRIX-8x8 product page at www.SnapAV.com.

10. OPERATION AND CONTROL

During setup and testing, use the included IR remote to control the matrix switcher. After setup is complete, a control method should have been setup and programmed as described in Section 6.7. *Matrix Control Connections* for regular operation.

10.1. IR Remote

This section describes the correct button-push sequences to perform regular operations with the IR remote. The **ENTER** key must be pressed within 10 seconds of the last command in order to be processed.

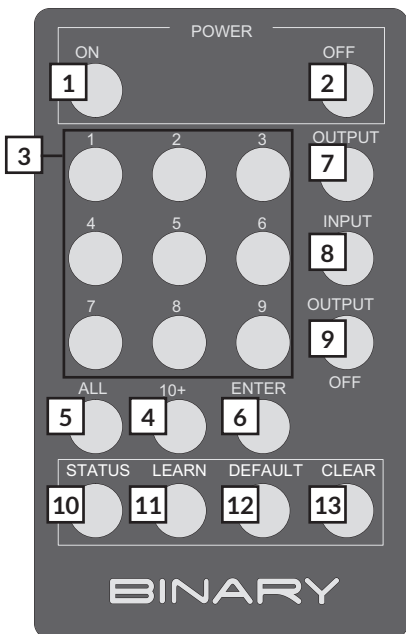

	Key	Function
1	ON	Power on the matrix switcher
2	OFF	Enter standby mode
3	Number Keys 1-9	Select a number
4	10+	Not used
5	ALL	Select all Inputs or Outputs
6	ENTER*	Enter to trigger the previous setting
7	OUTPUT	Begin Output selection
8	INPUT	Begin Input selection
9	OUTPUT OFF	Turn off/mute the selected Output
10	STATUS	Present EDID or Output status
11	LEARN	Learn EDID from one Output
12	DEFAULT	Begin embedded EDID selection
13	CLEAR	Clear the former IR operation procedure which user just pressed but has not yet applied by pressing ENTER

FIGURE 7 : Remote Functions

10.1.1. Route Inputs to Outputs

Input to Single Output Example: Output=3 Input=4	Display Readout (Example)
1. Press OUTPUT	--
2. Press Number Key (1-4) to select Output	3-
3. Press INPUT	3-
4. Press Number Key (1-8) to select Input	34
5. Press ENTER	34

Input to All Outputs Example: Output=All Input=4	Display Readout (Example)
1. Press OUTPUT	--
2. Press ALL to select all Outputs	A-
3. Press INPUT	A-
4. Press Number Key (1-8) to select Input	A4
5. Press ENTER	44

10.1.2. Turn Off (Mute) Outputs

Mute one Output Example: Output=1	Display Readout (Example)
1. Press OUTPUT	--
2. Press Number Key (1-8) to select Output	1-
3. Press OUTPUT OFF	10
4. Press ENTER	10

Mute All Outputs	Display Readout (Example)
1. Press OUTPUT	--
2. Press ALL to select All Outputs	A-
3. Press OUTPUT OFF	A0
4. Press ENTER	40

10.1.3. Display Output Status

	Display Readout (Example)	
	Example Output=3, Input=4	Example Output=3 Muted
1. Press STATUS	--	--
2. Press OUTPUT	--	--
3. Press Number Key (1-8) to select one Output	3-	3-
4. Press ENTER	34	30

10.1.4. Resetting to Factory Defaults

This procedure resets the B-120-HD-MATRIX to factory defaults:

- EDIDs - 1080p Stereo (embedded EDID 2)
- I/O - All Outputs set to Input 1
- 1CAT EDIDs cleared, DHCP - Enabled.

Reset Factory Defaults	Display Readout (Example)
1. Press DEFAULT	E-
2. Press DEFAULT	--
3. Press DEFAULT	--
4. Press DEFAULT	DD
5. Press ENTER	D-

Note: Resetting factory defaults can take up to 2 minutes to complete. Wait until the screen displays an output and input selection of 1.1 before attempting further setup or use.

11. TROUBLESHOOTING

If issues arise during installation or testing of the B-120-HDMATRIX-8x8, follow these guidelines to troubleshoot. Use the System Layout chart on the next page to record a description of each part of the system. If a problem cannot be solved using the methods listed here, fill out the System Layout Chart as completely as possible and contact Binary™ Tech Support for assistance at 866.838.5052.

11.1. General Troubleshooting Guidelines

- Always set up the connections between the matrix switcher and all equipment before attempting EDID setup or testing video and audio to be sure that all displays have been accounted for.
- Only change one part of a setup at a time when troubleshooting. Changing more than one variable may lead to inconsistent results.
- When any issue arises with video or audio, inspect the cable connections first.
- Try to simplify the signal route when troubleshooting. Remove any additional equipment from between the source and display as possible, and add one piece back until the issue re-appears.
- If a source will not work with all displays, or a display will only work with some sources, the issue is usually either an incorrect EDID for an input, or a source menu is set incorrectly.
- Swap devices to different ports on the matrix to determine whether issues follow the devices or the ports in use. Issues following sources are almost always related to the internal settings of the source. Set the source output to adjust automatically for the EDID of the display. Then set up the EDIDs using a learned EDID from an output with a problem display, or selecting an embedded EDID compatible with all of the connected displays' supported resolutions.

11.2. No Signal from Source to Any Display

If a source will not send a signal to any connected display, it is probably due to an issue with the cable in use, the EDID setting for the input, or the settings in the source:

- Swap the cable between the source and the input of the matrix for a short, working HDMI cable.
- Test the source using a different input. If the source works with displays when connected to a different input, the EDID needs to be changed to one that is compatible with all displays.
- If the problem follows the source, its output settings are not compatible with the displays in use, or the source is not working correctly. Test the source and set it up to work by connecting directly to a display with an HDMI cable.

11.3. No Signal from any Source to any Display

If a display connected to a matrix output will not sync to any source, the issue is usually either an incompatible EDID on all inputs or a problem with the cable connecting the display to the matrix switcher:

- Learn the EDID of the problem output to all inputs.
- Replace any HDMI cables with known working cables.
- Bypass all other equipment and wire directly from the output of the matrix to the input of the display with the shortest HDMI cable possible to eliminate other equipment as the cause of the issue.
- Connect the display wiring to a different matrix switcher output.
- Connect each source directly to the display using an HDMI cable and test to be sure the display and its input port work correctly with sources. If this works there may be HDMI wiring issues.

11.4. Audio Issues

If a display on an output using 2-channel stereo audio is switched to an input with an EDID set to surround sound audio format, audio at the display speakers may be garbled, missing pieces of the audio track, or muted altogether. This symptom indicates that the display cannot down-convert the audio stream from the source. To fix this issue, the source must be set to output only 2-channel stereo audio.

This may result in less-than-ideal audio quality in zones with surround systems; however with some sources like cable or satellite boxes, surround sound audio isn't critical to the end user experience, so these sources can send stereo audio through the speaker system with no perceived difference. For sources like Blu-ray players or streaming devices where sound quality is critical, the compromise would be to add a second source of the same type to the system so that one is set to stereo and one is set to surround sound.

12. SYSTEM LAYOUT CHART

Use this chart to identify the sources and displays attached to the system, and make any notes about each part. When completing the outputs chart, make sure to indicate whether an HDMI cable or HDMI extender is being used to extend signal to the display, and indicate the approximate length of any cables.

Input Number	Source Brand and Model	Location	Cable Length	Notes
1				
2				
3				
4				
5				
6				
7				
8				

Output Number	Source Brand and Model	Location	HDMI or Extender	Cable Length	Notes
1					
2					
3					
4					
5					
6					
7					
8					

13. SPECIFICATIONS

TECHNICAL	
HDMI Compliance	HDMI 3D
HDCP Compliance	Yes
Video Bandwidth	6.75Gbps
Input TMDS Signal	1.2 Volts (peak-to-peak)
Input DDC Signal	5 Volts (peak-to-peak, TTL)
ESD Protection	(1) Human body model – ±15kV (air-gap discharge) & ±8kV (contact discharge) (2) Core chipset – ±8kV
IR Signal (Bidirectional)	Carrier frequency: 20-60kHz
CONNECTIONS	
HDMI	16xHDMI Type A (19-pin female)
IR (In)	1x3.5mm Mono
RS-232	DB9
Power	Polarized
Ethernet	1xRJ45
MECHANICAL	
Housing	Metal enclosure
Dimensions (W x H x D)	17.32" x 1.73" x 6.38" (without ears)
Weight	5.1 lbs.
Power Supply	12V 5A
Matrix Power Consumption	30W
Operation Temperature	32~104°F
Storage Temperature	-4~140°F
Relative Humidity	20~90% RH (no condensation)
Certifications and Compliance	Product: CE, FCC, Rohs Power Supply: CE, FCC, Rohs, UL

14. CONTACTING TECH SUPPORT

Need Help? Contact Tech Support!

866.838.5052

For SnapAV customers, snapav.com

For Aisle 8 customers, onaisle8.com

15. WARRANTY

2-Year Limited Warranty

Binary™ products have a 2-Year Limited Warranty. This warranty includes parts and labor repairs on all components found to be defective in material or workmanship under normal conditions of use. This warranty shall not apply to products that have been abused, modified, or disassembled. Products to be repaired under this warranty must be returned to a designated service center with an assigned return authorization (RA) number. Contact technical support for an RA number.

BINARY®

Rev: 151008-0810