

MEDIA OVER IP SYSTEM
All B-900-MOIP-4K Units

BINARY

INSTALLATION & SETUP GUIDE



IMPORTANT SAFETY INSTRUCTIONS

To reduce the risk of fire or electric shock, read and follow all instructions and warnings in this manual. Keep this manual for future reference.

1. Do not expose to water.
2. Do not remove cover. No user serviceable parts inside.
3. Clean only with a dry cloth.
4. Leave sufficient space between devices and do not block ventilation holes for proper cooling.
5. Do not stack transmitter or receivers on top of each other.
6. Do not install near any device or source that generates heat.
7. Do not install near any heat sources such as radiators, heat registers, stoves or other apparatus (including amplifiers) that produce heat.
8. Do not override the safety purpose of the polarized or grounding plug. A polarized plug has two blades, one of which is wider than the other. A grounding plug has two matching blades and a third grounding prong. The wide blade or the third prong is provided for your safety. If the provided plug does not fit into your outlet, consult an electrician for replacement of the obsolete outlet.
9. Protect the power cord from being walked on or pinched, particularly at the plug end and where the power cord is attached to the apparatus.
10. Only use manufacturer's recommended power supply if the use of an external power supply for the transmitter and receiver is necessary.
11. Only use attachments and accessories specified by the manufacturer.
12. Refer all servicing to qualified service personnel. Servicing is required when the apparatus has been damaged in any way, such as when the power supply cord or plug is damaged, liquid has been spilled on or objects have fallen into the apparatus, the apparatus has been exposed to rain or moisture, the apparatus does not operate normally, or it has been dropped.
13. Disconnect the power supply cord from the power outlet, or disconnect the transmitter and receivers from the network PoE connections or remove the network switch power cord from the outlet, to completely disconnect the controller from power.

LEGAL NOTICE

Manufactured under license from Dolby Laboratories. Dolby, Dolby Audio, and the double-D symbol are trademarks of Dolby Laboratories.

For DTS patents, see <http://patents.dts.com>. Manufactured under license from DTS, Inc. DTS, the Symbol, DTS and the Symbol together, Digital Surround, and the DTS 2.0+Digital Out logo, are registered trademarks or trademarks of DTS, Inc. in the United States and/or other countries. © DTS, Inc. All Rights Reserved.

GETTING STARTED

To get started, you will need:

- 1× per source: MoIP Transmitter B-900-MOIP-4K-TX (or -2AC)
- 1× per display: MoIP Receiver B-900-MOIP-4K-RX (or -2AC)
- 1× MoIP Controller B-900-MOIP-4K-CTRL
- 1× Layer 2 Managed switch
- Sources, Displays, HDMI cables and category cabling

MoIP Controller B-900-MOIP-4K-CTRL

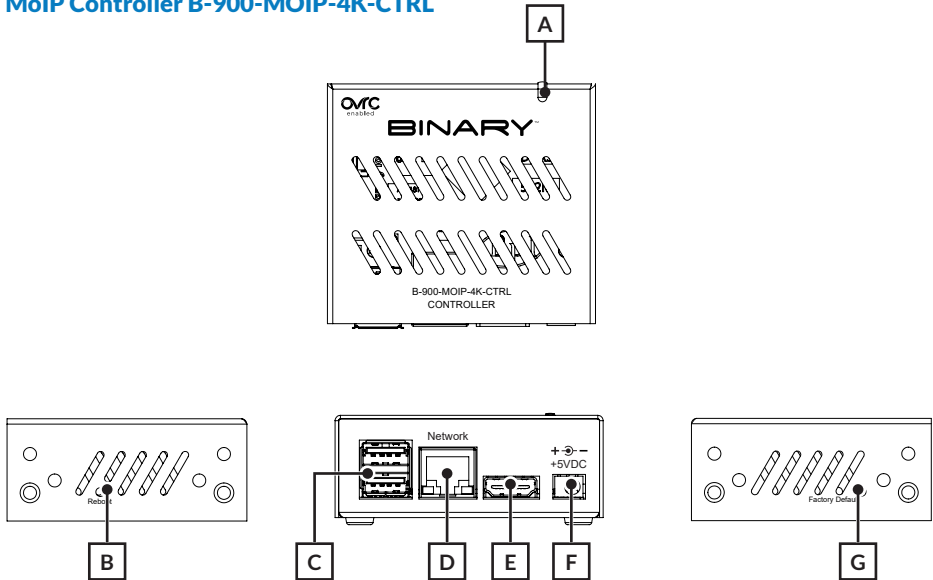

A. Status LED

Solid during system boot | Blinks during normal operation

B. Reboot Button

Use a pin to press the recessed button to restart

C. USB Ports

Not used for the MoIP system

D. Network/LAN Port

Connect to MoIP switch to provide access to MoIP transmitters and receivers

E. HDMI Port

Not used for the MoIP system

F. 12 VDC Power Connection

Connect the power supply provided

G. Factory Default button

Use a pin to press recessed button restore factory settings

MoIP Transmitter B-900-MOIP-4K-TX

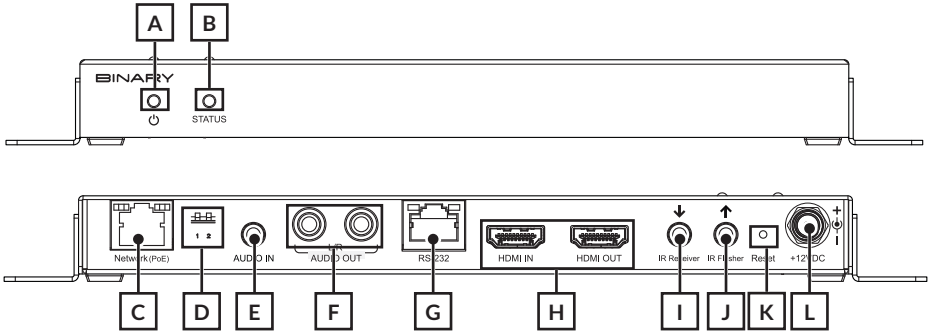

A. Power Indicator

On: Power on | **Blinking:** Booting | **Off:** Power off

B. System Status Light

On: Connected to network with source present | **Off:** Not connected to network |
Blinking: Connected to network and no source present

C. Network Port

Provides access to network and power via Power-over-Ethernet (POE)

D. DIP Switches

Switch 1: IR receiver on/off | **Switch 2:** DTE/DCE

E. 3.5 mm Input

Analog Audio embedding to replace HDMI audio

F. L/R Audio Out

RCA Analog audio de-embedding of 2-channel PCM audio

G. RS-232

RJ45, RS-232, (TX, RX, Ground), EIA-561 pin out

H. HDMI IN/OUT

HDMI source input and HDMI loop output for local display

I. IR Receiver

3.5 mm mini Mono/Stereo for external receivers

J. IR Flasher

3.5 mm mini Mono/Stereo output to IR emitter

K. Factory Reset

Press and hold for 10 seconds to restore to factory settings

L. 12 V 2A Power Connection

12VDC 2A locking connection for external power supply (**not included**)

MoIP Transmitter B-900-MOIP-4K-TX-2AC

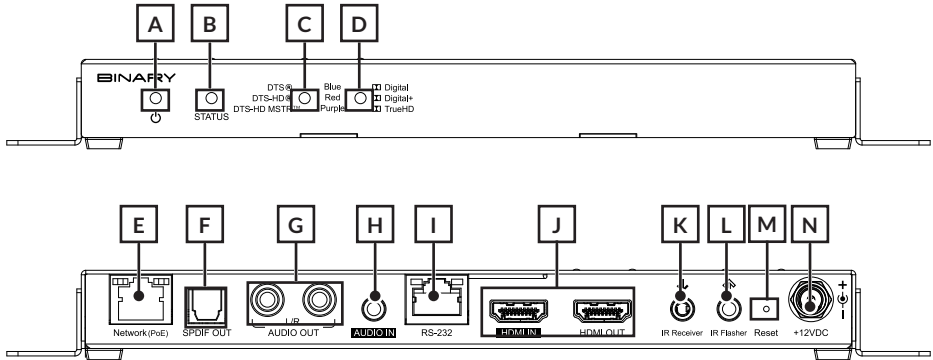

A. Power Indicator

On: Power on | Blink: Booting | Off: Power off

B. System Status Light

On: Connected to network with source present | Off: Not connected to network |
Blinking: Connected to network and no source present

C. DTS LED

Blue = DTS Surround; Red = DTS HD; Purple = DTS HD Master Audio

D. Dolby LED

Blue = Dolby Digital; Red = Dolby Digital Plus; Purple = Dolby True HD

E. Network Port

Provides access to network and power via Power-over-Ethernet (POE)

F. SPDIF Out

For future use only

G. L/R Audio Out

RCA Analog de-embedding of 2-channel PCM audio or downmixed bitstream audio

H. Audio In

3.5 mm input for embedding audio to replace HDMI audio

I. RS-232

RJ45, RS-232, (TX, RX, Ground), EIA-561 pin out

J. HDMI IN/OUT

HDMI source input and HDMI loop output for local display

K. IR Receiver

3.5 mm mini Mono/Stereo for external receivers

L. IR Flasher

3.5 mm mini Mono/Stereo output to IR emitter

M. Factory Reset

Press and hold for 10 seconds to restore to factory settings

N. 12 V 2A Power Connection

12VDC 2A locking connection for external power supply (not included)

MoIP Receiver B-900-MOIP-4K-RX

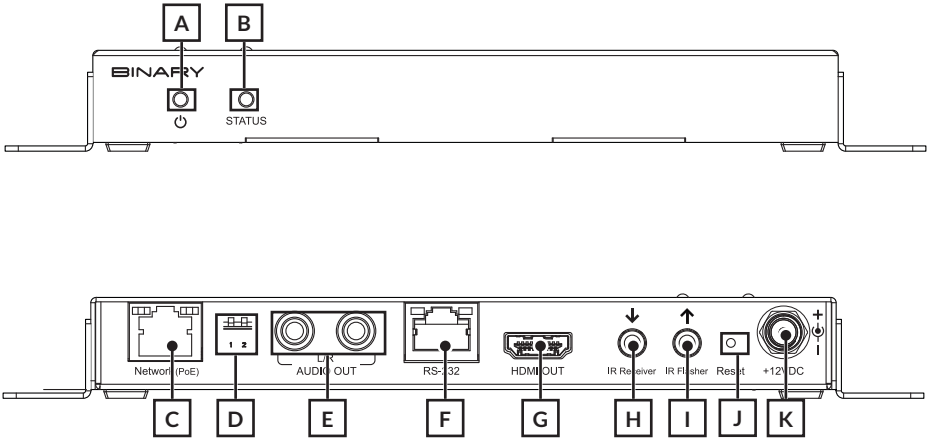

A. Power Indicator

On: Power on | **Blinking:** Booting | **Off:** Power off

B. System Status Light

On: Connected to network, not subscribed to transmitter stream | **Off:** Not connected to network | **Blinking:** Connected to network and subscribed to transmitter stream

C. Network Port

Provides access to network and power via Power-over-Ethernet (POE)

D. DIP Switches

Switch 1: IR receiver On/Off | Switch 2: DTE/DCE

E. L/R Audio Out

RCA Analog 2-channel PCM audio

F. RS-232

RJ45, RS-232, (TX, RX, Ground), EIA-561 pin out

G. HDMI OUT

HDMI output for local display

H. IR Receiver

3.5 mm mini Mono/Stereo for external receivers

I. IR Flasher

3.5 mm mini Mono/Stereo output to IR emitter/flasher

J. Factory Reset

Press and hold for 10 seconds to restore to factory settings

K. 12 V 2A Power Connection

12VDC 2A locking connection for external power supply (**not included**)

MoIP Receiver B-900-MOIP-4K-RX-2AC

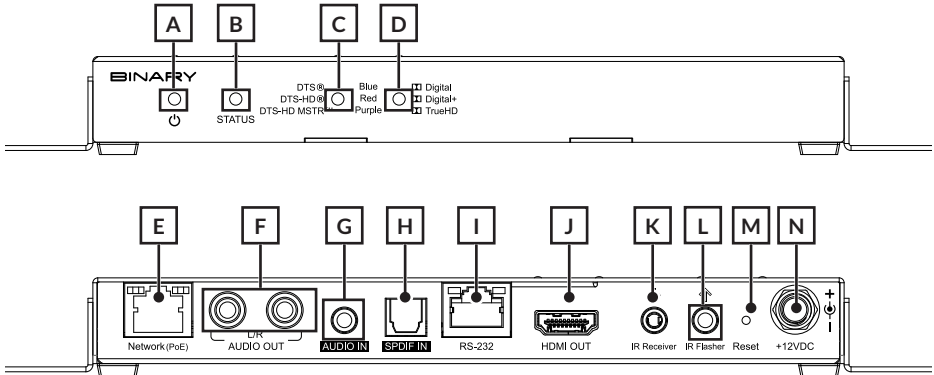

A. Power Indicator

On: Power on | **Blinking:** Booting | **Off:** Power off

B. System Status Light

On: Connected to network, not subscribed to transmitter stream | **Off:** Not connected to network | **Blinking:** Connected to network and subscribed to transmitter stream

C. DTS LED

Blue = DTS Surround; Red = DTS HD; Purple = DTS HD Master Audio

D. Dolby LED

Blue = Dolby Digital; Red = Dolby Digital Plus; Purple = Dolby True HD

E. Network Port

Provides access to network and power via Power-over-Ethernet (POE)

F. L/R Audio Out

RCA Analog 2-channel PCM audio

G. Audio In

3.5 mm input for embedding audio to replace HDMI audio

H. SPDIF In

For future use only

I. RS-232

RJ45, RS-232, (TX, RX, Ground), EIA-561 pin out

J. HDMI OUT

HDMI output for local display

K. IR Receiver

3.5 mm mini Mono/Stereo for external receivers

L. IR Flasher

3.5 mm mini Mono/Stereo output to IR emitter/flasher

M. Factory Reset

Press and hold for 10 seconds to restore to factory settings

N. 12 V 2A Power Connection

12VDC 2A locking connection for external power supply (**not included**)

NETWORKING

This section details the networking requirements, recommendations and limitations when configuring a Binary B-900 Series Media over IP system (MoIP) system which can be used to deploy MoIP on any compatible network switch. Also, you will find the simple steps to configure an Araknis 210 Series PoE and 310 Series PoE Layer 2 managed switch in a single switch MoIP deployment as well as basic guidelines, requirements for single and multiple switch MoIP setups.

IMPORTANT: Network switches directly connected to MoIP Transmitters and MoIP Receivers should always be configured prior to connecting any of these components.

RECOMMENDED NETWORK SWITCHES

Single Switch Deployments

Araknis Switch Model	Ethernet Ports (1 Gbps)	SFP Ports (1 Gbps)	PoE Budget (Watts)
AN-210-SW-F-48-PoE	48	4	375
AN-210-SW-F/R-24-PoE	24	2	190
AN-210-SW-F/R-16-PoE	16	2	130
AN-210-SW-F/R-8-PoE	8	2	65
AN-310-SW-F/R-24-PoE	24	2	375
AN-310-SW-F/R-16-PoE	16	2	250
AN-310-SW-F/R-8-PoE	8	2	130

Multiple Switch Deployments

Araknis switches do NOT support multiple switch setups at this time. In setups where MoIP transmitters and MoIP receivers must be connected on multiple extended switches, multiple gigabit uplinks between switches is required. Numerous network switch manufacturers offer switches with multiple gigabit uplink/SFP ports to support multiple switch deployments. [Check our website for the latest supported switches.](#)

SELECTING A NETWORK SWITCH

Network Switch Requirements

The Ethernet PoE switch selected is critical for the optimal performance of the MoIP system. Araknis 210 Series and 310 Series PoE switches are recommended. Switch functionality, capability and reliability can vary greatly from one manufacturer to the next. Configuration will vary by manufacturer. Refer to the manufacturers user manual to enable required features to support MoIP. Some brands of switches may have limited support of required functions, bandwidth across the entire switch, and necessary total PoE power to support all MoIP Transmitters and Receivers.

Network Switch Minimum Requirements

A network switch selected for a MoIP system must meet the requirements below or support the following features:

Single Switch Deployments

- Layer 2 or Layer 3 Managed
- 1 Gigabit Ethernet Port Throughput (minimum)
- Simultaneous 7.5 Watts PoE across all ports (minimum)
- Multicast forwarding or filtering
- IGMP Snooping
- IGMP Querier
- IGMP Snooping Fast Leave
 - Also known as Instant Leave or Immediate Leave
- Jumbo Frames (8000 bytes or larger)
 - Also known as Jumbo Packets or Maximum Transmission Unit

If a **multiple switch deployment** is required, the switches must also support:

- Dynamic Multicast Router Port
- Forwarding Unknown Multicast to Multicast Router Port Only

Note: It is highly recommended that the above features be **applied to all network switches** on the same LAN as MoIP as a best practice. This is not required; however, highly recommended.

Number of Ports

Given the flexibility and scalability of Binary's B-900 Series Media over IP system, it is recommended that a switch with more Ethernet ports than needed for the MoIP system be used to allow quick addition of devices in the future. Utilizing an Araknis 210 Series 48-port PoE switch, a MoIP system maximum size limit is 47 total MoIP Transmitters and MoIP Receivers. Larger systems utilizing other manufacturer's switch is possible in both single and multiple switch deployments.

When calculating the size of switch needed, count one port for each the following devices:

15. Number of sources (MoIP Transmitters)
16. Number of displays (MoIP Receivers)
17. MoIP Controller
18. LAN connection to main network for OvrC (if applicable)

Power

The MoIP Transmitters and MoIP Receivers can be powered by **Power-over-Ethernet (PoE)** or a separate **12V power supply (not included)**. The separate power supply is available only as a replacement part only. TX and RX will each utilize no more than 7.5 watt of power. Snap AV recommends using PoE to power the MoIP TX and RX units. The MoIP Controller is NOT powered by PoE and requires the use of the included 12V power supply.

MoIP System Network Setups

Single switch MoIP network configurations are supported by Araknis 210 PoE and 310 PoE Series switches. Integrators familiar with the above requirements and the configuration of stackable and cascaded switches with multi-gigabit uplinks will be able to create very large MoIP deployments.

Single Switch

Dedicated MoIP Switch (RECOMMENDED)

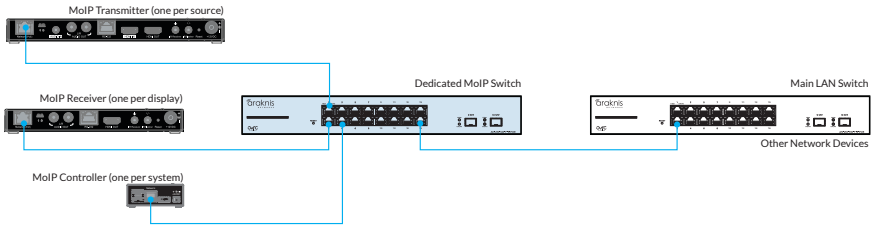

Shared MoIP Switch

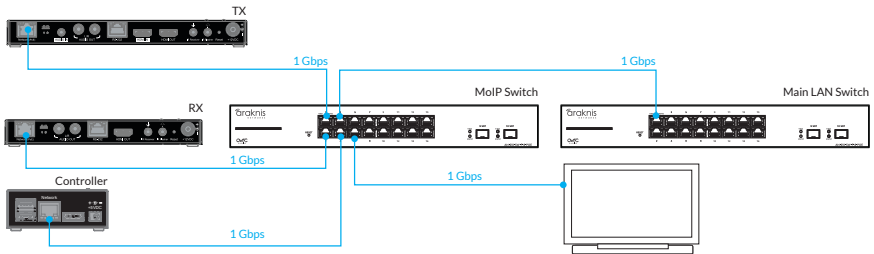

MoIP on Main LAN Switch

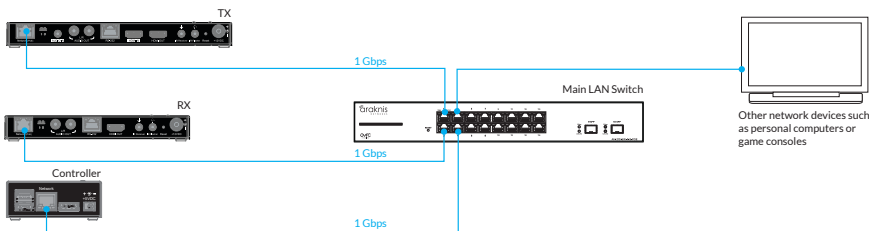

Multiple Switches

Please refer to your network switch manufacturers' documentation to enable the critical features for optimal performance in multiple switch MoIP network configurations.

Bandwidth considerations are critically important. The maximum number of MoIP Transmitters which can be supported by a given network topology is limited by the lowest bandwidth link in the network. Typically, this will be the link between switches. MoIP Receivers

have no impact on available bandwidth. The bandwidth requirements of other devices on the network should also be considered.

Each MoIP Transmitter will consume 250-850 Mbps (4K) or 150-750 Mbps (1080p) of the available bandwidth. The lowest bandwidth link limitation applies no matter to which switch in the multiple switch setup the transmitter is connected. To calculate the required bandwidth needed to support the desired number of MoIP Transmitters, multiply the number of MoIP Transmitters by 0.85. This will give you the bandwidth in Gbps. For example, 10 MoIP transmitters would require 8.5 Gbps. In the diagrams below, **X Gbps** indicates a multiple gigabit connection between switches. The throughput of this uplink must accommodate, for this example, 8.5 Gbps for the MoIP system to operate optimally.

Cascaded Switches

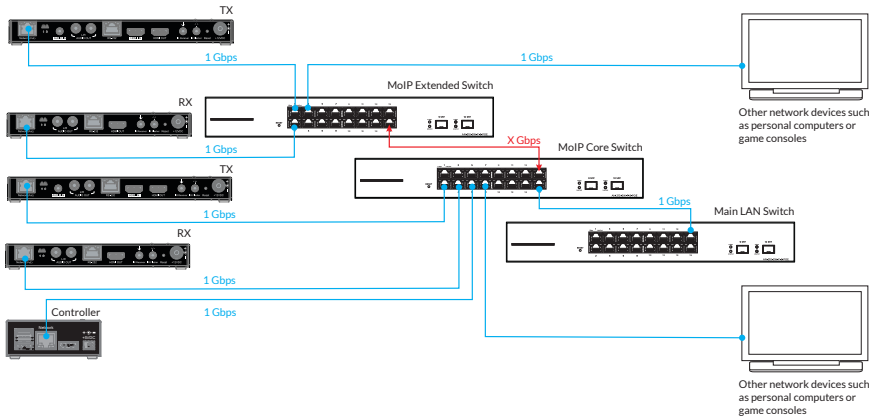

Stacked Switches

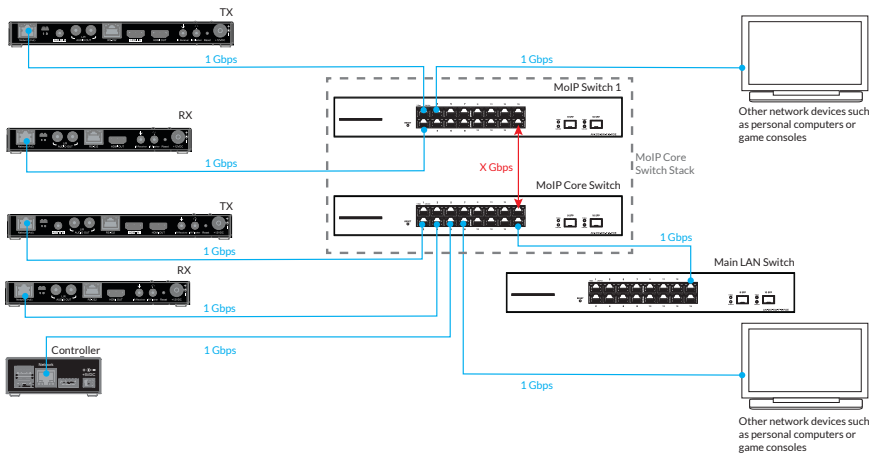

ARAKNIS 210/310 PoE SERIES CONFIGURATION

1. Configure Network Switch

Steps below use an Araknis 210 PoE or 310 PoE Series switch as an example

1. Factory default the **MoIP switch** to be used for all MoIP Components (not necessary for new switches). Press and hold the reset button for 10–15 seconds until the Status LED flashes once. This will reboot the switch and reset to factory settings.
2. Connect the dedicated MoIP switch directly to your **Main LAN switch**. (The Main LAN switch is the main network switch into which all other switches and network devices are connected. The Main LAN switch is the only switch connected to the router. A dedicated MoIP switch is preferred but not required. See 'Network Guide' for more information.)
3. Access the local of the **MoIP Switch**.

Note: Default login in credentials for an Araknis which are araknis / araknis. The Default IP address is 192.168.20.254.

2. Enable IGMP Snooping

Choose **ADVANCED > MULTICAST > IGMP SNOOPING**, then check options as follows:

3. Status: **Enabled**
4. Version: **V2**
5. Report Suppression: **Enabled**
6. Unregistered IPMC Forward Action: **Drop**
7. IGMP Snooping Status: **Enabled**
8. Fast Leave: **Enabled**
9. Querier State: **Enabled**
10. Querier Version: **V2**
11. Router Settings > Router Ports Auto-Learned: **Enabled**

Click **Apply** to save these settings

3. Verify Jumbo Frame

Choose **SETTINGS > PORTS**, then verify **Jumbo Frame** is set to greater than 8,000 Bytes. The default value is 9216 the maximum is acceptable.

4. Set up the MoIP Controller

Claim **MoIP controller** on OvrC and access the local UI.

IMPORTANT: This is **REQUIRED** for firmware maintenance.

1. For existing OvrC locations:

- a. Log into OvrC and go to **Customer > Devices**
- b. A new device will show ready to add. Click “+ Device”, > ‘Media Devices’ and follow the prompts to claim the MoIP controller.

2. New OvrC locations

- a. Document the MoIP Controller MAC Address and Service Tag on the box or on the bottom of the device
- b. Log into OvrC and go to Customer > Devices, click “+ Device”
- c. Manually enter MAC Address and Service Tag to claim the device

Customer
The Holdens
Location
Drummond

Please enter the MAC address of an installed device

Find

Supporting over 100 models from these brands and more:

5. Access Local UI using Remote Access

Connect the controller to the MoIP Switch, then use the external power supply to connect to an AC outlet.

1. Once connected, log into the MoIP Controller (username/password is binary/binary). You can change the user name and password under the **Configure > Account Management**.
2. It is **recommended to apply a static IP address**. Navigate to the **Configure > IP Settings** and click **Enable**. Apply a static address to the MoIP controller on the same ip address range. Click **Save** to apply.

6. Update the MoIP Controller Firmware

Available firmware updates are visible in the **Device List** for that location in OvrC. Follow steps provided in OvrC to complete.

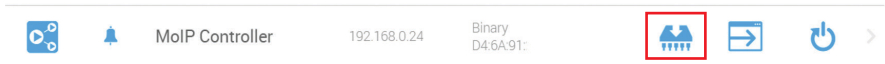

7. Power off the MoIP Switch, then Connect Devices

1. Connect sources via HDMI to the MoIP Transmitters.
2. Connect displays or A/V receivers via HDMI to the MoIP Receivers.
3. The transmitter and receiver are PoE powered (no power supply is included).
4. The controller must be powered by the included external power supply.

8. Powering Up the System

1. Turn on all displays, sources and other related A/V equipment
2. Verify the MoIP Controller is also powered up.
3. Apply power to the MoIP Switch. This will supply power on all connected MoIP devices.

9. Discover MoIP Transmitters and MoIP Receivers

Access the local UI of the MoIP controller and click **Discover** and confirm to activate.

The screenshot shows the 'Binary MoIP Flex' web interface. At the top, there are tabs for 'DETAILS', 'CONFIGURE', and 'SYSTEM LOG'. On the right, there are buttons for 'FACTORY DEFAULT', 'UPDATE', and 'REBOOT'. Below the tabs, the 'System Settings' section displays the following information:

SYSTEM NAME	MODEL	SERIAL NUMBER	MAC ADDRESS	IP ADDRESS	FIRMWARE VERSION
MoIP-Controller	B-900-MOIP-CTRL	13237809	02:81:D4:C9:FE:31	192.168.0.208	1.0.0.1

Below the settings, there are two toggle switches: 'Test Mode' and 'Identify Mode', both currently turned off. To the right of these toggles are two buttons: 'DISCOVER' and 'REBOOT ALL'. Below this section, there are two main areas: 'Transmitters' and 'Receivers'. Both areas currently show a message: 'There are no transmitters/receivers connected'. There is an 'ADD VIDEO WALL' button in the top right corner of the Receivers section.

Transmitters

This screenshot displays the 'Transmitters' section of the MoIP controller UI. It shows 10 discovered transmitters, each with a unique ID and a small video preview. The transmitters are:

- TX-D46A91210205 (Streaming B-900-MOIP-4K-TX D46A91210205)
- TX-D46A912105AF (Streaming B-900-MOIP-4K-TX D46A912105AF)
- TX-D46A91210044 (Streaming B-900-MOIP-4K-TX D46A91210044)
- TX-D46A9121057D (Streaming B-900-MOIP-4K-TX D46A9121057D)
- TX-D46A91210014 (Streaming B-900-MOIP-4K-TX D46A91210014)
- TX-D46A91210005 (Streaming B-900-MOIP-4K-TX D46A91210005)
- TX-D46A91210048 (Streaming B-900-MOIP-4K-TX D46A91210048)
- TX-D46A9121060B (Streaming B-900-MOIP-4K-RX D46A9121060B)
- TX-D46A9121061D (Streaming B-900-MOIP-4K-RX D46A9121061D)
- TX-D46A91210635 (Streaming B-900-MOIP-4K-RX D46A91210635)
- TX-D46A9121060E (Streaming B-900-MOIP-4K-RX D46A9121060E)

An 'ADD VIDEO WALL' button is located in the top right corner of the section.

Receivers

This screenshot displays the 'Receivers' section of the MoIP controller UI. It shows 4 discovered receivers, each with a unique ID and a small video preview. The receivers are:

- RX-D46A9121060B (Streaming B-900-MOIP-4K-RX D46A9121060B)
- RX-D46A9121061D (Streaming B-900-MOIP-4K-RX D46A9121061D)
- RX-D46A91210635 (Streaming B-900-MOIP-4K-RX D46A91210635)
- RX-D46A9121060E (Streaming B-900-MOIP-4K-RX D46A9121060E)

Each receiver card includes the text 'Paired Transmitter Source'. An 'ADD VIDEO WALL' button is located in the top right corner of the section.

The discovery process identifies all transmitters and receivers on the system and displays. Devices will be discovered and assigned a transmitter or receiver number. Transmitter and receiver numbers will correlate directly with the inputs or outputs respectively for control system integration, similar to traditional matrix switchers.

If the assigned transmitter and receiver numbers do not fit an existing pre-written program, numbers can be re-assigned via the configuration tab of the UI.

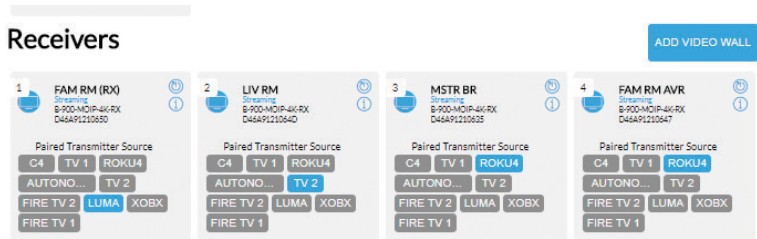

10. Update TX and RX Firmware (if necessary)

1. If a firmware update is required on any of the transmitters and receivers, a banner will appear on the MoIP controller main page.

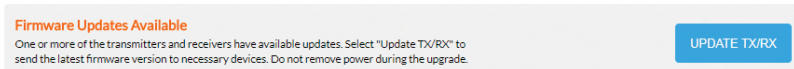

2. Click **UPDATE TX/RX**. This will apply the firmware update to any or all devices as required.
 3. Each individual device will show **Updating** in red.
- IMPORTANT:** Do NOT remove any devices or reboot until all have completed update status.

11. Identify Receiver-Display and Transmitter-Source Pairs (Recommended)

1. Click the **i** under each device to name each transmitter. Use the screen capture from each source to help identify each transmitter.

Transmitters

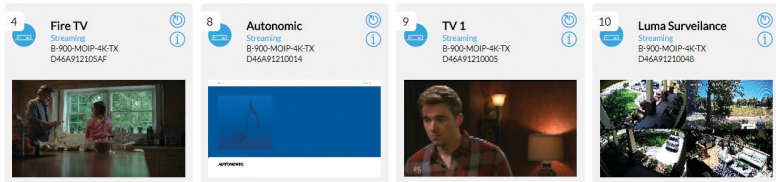

2. Record the Transmitter number, MAC address and connected source for use during control system integration.
3. Activate **Identify Mode** via the MoIP controller UI. Each display connected to each receiver will display the MAC address for the receiver connected to that display.
4. Name each receiver based on the MAC address.

Receivers

ADD VIDEO WALL

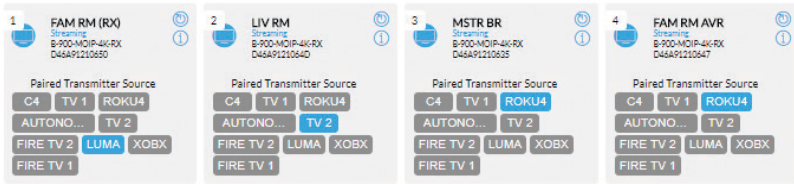

- Record the Receiver number, MAC address, and connected display type/location for use during control system integration.

Note: In **Test** mode, 4K content does not show on a 1080p TV or via 1.4 HDCP connection. Downscaling can be configured to fix this by clicking **i** next to each receiver.

12. Configure the MoIP Transmitters

- The audio EDID between the MoIP Transmitter and the source can be fixed to 2 Channel Stereo or 5.1 Multichannel. By default, the device is shipped with this set to Pass-through. Pass-through allows all multi-channel high audio resolution formats including DTS-X, Dolby ATMOS, DTS HD Master Audio, and Dolby True HD.
- If a device connected to a MoIP Receiver has limited audio capabilities, please configure the MoIP Transmitters to limit the audio EDID presented to the source to the most common format (5.1 or 2ch).
 - If the MoIP Transmitter Audio EDID to 2 Channel Stereo, all MoIP Receivers will hear the 2 channel stereo audio from the HDMI source.
 - All TVs in the system can process 5.1 Dolby Digital and DTS 5.1 but only the home theater AVR can process Dolby ATMOS, then configure the MoIP Transmitter Audio EDID to 5.1 Multichannel mode.
 - If one or more MoIP Transmitters are dedicated to the home theater, then those MoIP Transmitter Audio EDID settings should be configured for Pass-through.
- The audio source for the transmitter can be configured to be HDMI, or to use the analog input instead via the **Local Audio Input** setting.
- When using a transmitter with downmixing (B-900-MOIP-4K-TX-2AC), you can configure audio latency (up to 250 milliseconds). *Audio latency can be adjusted while streaming content.* All other settings must be saved before they take effect

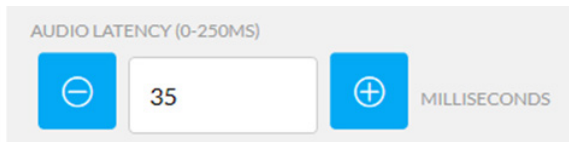

Note:

- Disabling power saving settings on connected sources helps maintain accessibility to the video stream.

Binary MoIP

Screenshot of B-900-MOIP-4K-TX

DETAILS CONFIGURE SYSTEM LOG

Transmitter Details

TRANSMITTER NAME
Roku

General Information

MAC ADDRESS	MODEL	FIRMWARE VERSION	STATUS
D46A91218C5B	B-900-MOIP-4K-TX	v1.0.18	Streaming

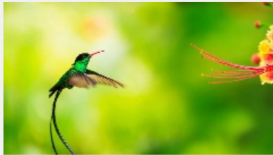

REFRESH

Video Details

VIDEO RESOLUTION	HDCP VERSION	FRAMERATE	SCAN MODE	COLOR DEPTH	PIXEL RATE	SIGNAL TYPE
[1280]X[720]	2.2	[60]	Progressive	24	74175KHz	HDMI 16:9

AUDIO EDID

Pass-Through

- Pass-Through
- Force 2-Channel
- 5.1 Multi Channel

REMOVE CANCEL SAVE

Binary MoIP

Screenshot of B-900-MOIP-4K-TX-2AC

DETAILS CONFIGURE SYSTEM LOG

Transmitter Details

TRANSMITTER NAME
TX-D46A91218D0E

General Information

MAC ADDRESS	MODEL	FIRMWARE VERSION	STATUS
D46A91218D0E	B-900-MOIP-4K-TX-2AC	v2.0.27	No Source



REFRESH

IR RECEIVER 12V

SERIAL MODE DCE DTS

Video Details

VIDEO RESOLUTION	HDCP VERSION	FRAMERATE	SCAN MODE	COLOR DEPTH	PIXEL RATE	SIGNAL TYPE

AUDIO EDID

Pass-Through

- Pass-Through
- Force 2-Channel
- 5.1 Multi Channel

AUDIO LATENCY (0-250MS) ⓘ

100 MILLISECONDS

REMOVE CANCEL SAVE

13. Configure the MoIP Receivers

1. For displays that only support 1080p and/or HDCP 1.4, set the corresponding receiver to match this requirement to allow video to pass. 4K video input into transmitters will not show on 1080p and/or HDCP 1.4 displays.
2. Set each receiver individual to **Passthrough** for the displays capable of support 4K HDR as this will allow the HDR metadata to pass resulting in 4K HDR 30Hz.
3. Set each receiver to 2160p 30Hz to displays that are 4K however; do not support HDR.
4. If desired, choose drop down for **Rotation** (90°, 180°, or 270°).

If using a receiver with audio downmixing capability (B-900-MOIP-4K-RX-2AC):

5. Select the HDMI Audio setting:

(a) **Auto** - Determines the best audio setting based on the signal chain.

(b) **2CH** - Forces the source device to only output 2 channel PCM.

(c) **Bypass** - Makes no modifications to the incoming signal. It is possible in this mode that an incompatible incoming format results in no audio output from the receiver.

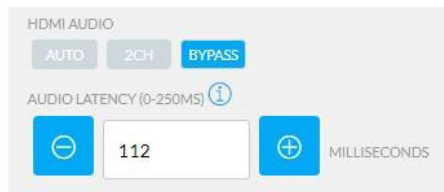

6. If audio does not match the video, adjust the audio latency (up to 250 milliseconds). *Audio latency can be adjusted while streaming content.* All other settings must be saved before they take effect.

Note:

- The video output resolution can be set to 2160p (4K) at 30Hz or 25Hz or 1080p (2K) at 60Hz or 50Hz.
- Since each receiver always outputs 4K 30Hz 4:4:4 8 bit color. 4K HDR will be limited to 8-bit color only; however, the display will show content as 4K HDR and output higher brightness and contrast.

[DETAILS](#) [CONFIGURE](#) [SYSTEM LOG](#)

Receiver Details

RECEIVER NAME

General Information

MAC ADDRESS: D46A91210ACA MODEL: B-900-MOIP-4K-RX FIRMWARE VERSION: v1.0.11 STATUS: Streaming

MAX VIDEO RESOLUTION: **Pass-Through** HDCP: **Pass-Through** ROTATION: **No Rotation**

MAX VIDEO RESOLUTION	HDCP	ROTATION
Pass-Through	Pass-Through	No Rotation
Full HD 1080p60	2.2	180 Degrees
Full HD 1080p50	1.4	90 Degrees
Ultra HD 2160p30		270 Degrees
Ultra HD 2160p25		

Video Details

VIDEO RESOLUTION	HDCP VERSION	FRAMERATE	SCAN MODE	COLOR DEPTH	PIXEL RATE	SIGNAL TYPE
[1920]x[1080]	N/A	[60]	Progressive	24	148351KHz	HDMI 16:9

[DETAILS](#) [CONFIGURE](#) [SYSTEM LOG](#)

Receiver Details

RECEIVER NAME

General Information

MAC ADDRESS: D46A91218D5C MODEL: B-900-MOIP-4K-RX-2AC FIRMWARE VERSION: v2.0.27 STATUS: Streaming

MAX VIDEO RESOLUTION: **Pass-Through** HDCP: **Pass-Through** ROTATION: **No Rotation**

MAX VIDEO RESOLUTION	HDCP	ROTATION
Pass-Through	Pass-Through	No Rotation
Full HD 1080p60	2.2	180 Degrees
Full HD 1080p50	1.4	90 Degrees
Ultra HD 2160p30		270 Degrees
Ultra HD 2160p25		

Video Details

VIDEO RESOLUTION	HDCP VERSION	FRAMERATE	SCAN MODE	COLOR DEPTH	PIXEL RATE	SIGNAL TYPE
[1280]x[720]	1.x	[60]	Progressive	24	74175KHz	HDMI 16:9

HDMI AUDIO:

AUDIO LATENCY (0-250MS): MILLISECONDS

Create a Video Wall

A video wall can be created with receivers currently discovered by the MoIP Controller. After creating the wall, it will be added to the **Receiver** list alongside the existing receivers. 4x4, 3x3 and 2x2 video walls can be created out of 16, 9 and 4 receivers.

Binary MoIP



DETAILS CONFIGURE SYSTEM LOG

Video Wall Settings

Video Wall Details

Video Wall Name

ex. LivingRoom VideoWall

Display Type



2x2



3x3



4x4

Receiver Screen Placement

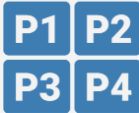

Position	Receiver
P1	Select Receiver ▼
P2	Select Receiver ▼
P3	Select Receiver ▼
P4	Select Receiver ▼

Bezel Adjustments

Enable

TV Outer Dimensions	<input type="text" value="0"/> <input type="text" value="0"/>	TV Screen Dimensions	<input type="text" value="0"/> <input type="text" value="0"/>
WIDTH (mm)	HEIGHT (mm)	WIDTH (mm)	HEIGHT (mm)

BEZEL CORRECTION GUIDE (IN MILLIMETERS)

DELETE

CANCEL

SAVE

To create a video wall:

1. Name the video wall (required)
2. Select the video wall size (2x2, 3x3, 4x4) by clicking the matching size
3. Based on your installation, assign a given receiver to each position "PX" of the video wall.
4. Measure the display screen dimensions as indicated to adjust out the video that falls behind each TV bezel
5. Click **Enable** to adjust the bezel
6. Enter the dimensions
7. Click **Save**

The updated video wall receivers are now available and will integrate with a control system as another output like all other receivers. Additional control system steps may be required to properly switch control for a video wall.

Set up Control System

Integrating MoIP with your chosen control system is very similar to the steps to integrate a matrix switcher. The Binary team has developed custom drivers and worked with control system manufacturers to certify. The following control system drivers, models and documentation are available:



Please refer to individual driver support documents for specific features and capabilities.

For greater control and integration, the full application programming interface (API) [MoIP API](#) for the MoIP Controller is available for download on the support tab.

- Basic switching control: An IP control system is required to control the system transmitter-receiver switching. No serial or IR system switching control is supported.
- RS-232/Serial Generation: RS-232/Serial commands are generated at each transmitter and receiver. Make connections from the receiver or transmitter end points directly to the devices to be controlled. RS-232 commands sent over IP and are generated at each end point. To integrate, in the control system driver, link each transmitter and receiver's serial port to the devices to be controlled. Refer to the Serial & IR Control document for more.
- Infrared (IR) Routing: Infrared control signals are passed bi-directionally over the static routes establish on the [IR Links Settings](#) page on the MoIP controller local user interface (UI). These routes create virtual wires simplifying the integration process. To integrate these static 2-way IR routes with the control system, link control system IR outputs directly to the device to be controlled based on the IR Link settings. Refer to the Serial & IR Control document for more information.
- CEC Stand-by & Power On: CEC can be enabled via the control system driver and supports Stand-by and Power On commands. Details of this are provided in specific driver documentation. CEC compatibility varies between display manufacturers and should be tested for each install to ensure maximum reliability. Other control options may be required for your specific application.
- Audio De-embedding: The L/R stereo audio outputs on the transmitter and receiver, when stereo content is present, extracts this audio for convenient input into multi-room audio distribution systems. No control system integration is necessary.

End User App

- [Visit Configure > Client Control App Settings](#) via the controller UI to enable client control outside of a control system. This allows clients to easily change input sources for each video display from their tablet or mobile device. Configure scenes to create common display templates (e.g., Fight Night, etc.) across a location.
- We recommend a DHCP reservation or static IP address when using this feature.
- Visit <http://<system static IP>/control> on the client device and choose "Save to Home Screen." This makes the page behave like a native mobile app on iOS and Android.
- Select a Display. Available Tx content appears to scroll through on the bottom of the screen.
- Choose the picture icon in the top left to name a scene.
- Choose the refresh icon (top right) to refresh available displays, sources, and screen shots.

Client Control App Settings

Enable Client Control

[VIEW APP](#)



<http://192.168.1.147/control>

- Allow clients to easily change input sources for each video display from their tablet or mobile device.
- Configure scenes to create common display templates (i.e. Fight Night, etc.) across a location.

On mobile and tablet devices, we highly recommend to "Save to Home Screen" after visiting the URL. This will make the page behave like a native mobile application on iOS and Android devices.

A DHCP reservation or [static IP address](#) is recommended when using this feature.

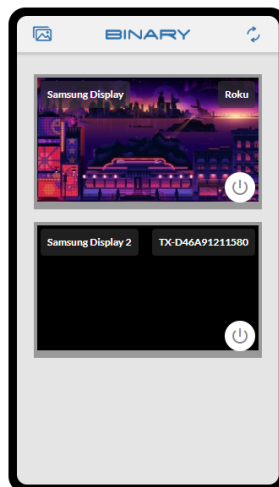

Two (2) Year Limited Warranty

This Binary product has a Two-Year Limited Warranty. This warranty includes parts and labor repairs on all components found to be defective in material or workmanship under normal conditions of use. This warranty shall not apply to products that have been abused, modified or disassembled. Products to be repaired under this warranty must be returned to a designated service center with an assigned return authorization number (RA). Contact technical support for an RA number.

SUPPORT

Need Help? Contact Tech Support!

If you need further clarification, please call tech support at **866.838.5052**, or email support@snapav.com. For other information, instructional videos, support documentation, or ideas, visit our website and view your item's product page at www.snapav.com.

BINARY

Rev: 200421-1615
© 2019–2020 Binary